

V4.25

User's manual

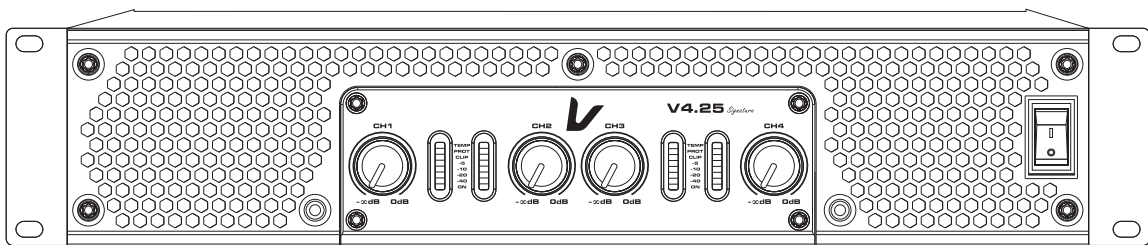



目录表

重要安全事项和符号说明.....	1
前言.....	2
前板功能介绍.....	3
后板功能介绍.....	4
技术指标.....	5
故障排除.....	6









Table of contents

Important Safety Instruction and symbol description.....	7
Foreword.....	8
Front panel functions.....	9
Rear panel functions.....	10
Specifications.....	11
Troubleshooting.....	12

重要安全事项

1. 阅读这些规定，注意所有警告，遵守这些规定。
2. 严禁在产品周围喷洒液体。请勿在产品上方放置液体容器，如花瓶等。可使用干布及风枪进行清洁。
3. 注意不要形成热风循环。按建议方法进行安装。
4. 不将产品安装在热源附近，尽可能保证环境气温在35°C以下。
5.  接地保护，当产品接通电源时，应采取相应的接地保护措施。
6. 请保护好电源线，防止其受到踩踏或挤压，尤其要注意插头、电源插座及其连接设备处。
 警告：电源插头/设备耦合器作为电路切断装置，应保持随时可用。
7. 必须按照以下开关次序来使用该产品：（开）前级-功放、（关）功放-前级。
8. 通电前必须确保供电电压符合该产品的要求。
9. 若输入信号并接超过三台功放，建议使用信号分配器，以确保输入信号不失真。
10. 不要将功放的某一个声道的输出接口接到另一个通道的输入接口。不要将功放的输出并联或串联到另一台功放的输出接口。
11. 设计系统配置功放的时候，功放的功率应比音箱在相同阻抗下的标称功率大50%-100%，且小心使用桥接模式。
12. 在维修功放的时候，禁止在桥接状态下将示波器的探头 连接到功放的输出端，以免损坏功放和示波器。
13. 建议：1) 由于输出到音箱的电流较大，建议使用质量有保证的NL4型音箱螺旋插头。
2) 多台功放使用时应计算好合适的配电，以确保达到合格的使用环境。

安全说明

	输入/输出接驳线缆不可堆叠在产品排风窗口，请置于功放两侧捆扎好!		本产品仅适用于海拔2000m以下安全使用。 (仅限于本公司的开关电源设备)
	非水平堆叠时，建议机尾排风口向上或直向排风口。		本产品仅适用于非热带气候条件下安全使用。
	工作环境气温应<35°C。		需经专业回收的物料，不能放置入垃圾桶。
	在工程调试时验证机柜内气温，在极限条件下，也应保持在35°C以下。		小心触电，非拥有相关资质的人员请勿擅自开盖维修。



警告 为避免着火或电击，不要将产品暴露在雨中或潮湿的环境中。

欢迎

非常感谢您购买蜚声演出器材制造有限公司产品。V4.25产品是公司专为大型体育场馆、大型演出、电影院、剧场的音响系统而设计。为了更好的发挥产品性能，请在使用前仔细阅读本手册。

拆包

请在拆开包装后，确认功放的外观没有在运输途中遭到损坏。确认功放的预设电压和你所在地的交流电压额定值匹配（详细信息见功放背板印刷）建议您保留包装箱，以便在需要退还产品时使用。

重要的安全注意事项

本产品在设计时已经充分考虑安全使用要求，并遵照国家相关安全法规生产及检验后出厂销售；本产品为I类电器，因此要求用户端的供电电源必须按三线制（相线、零线、地线）向本产品供电；同时，但由于本产品内部有危险高压和电量，如发现本产品有跌落、凹入、浸湿或者里面有部件松动，则会大大增加触电危险，请马上切断电源，将本产品送指定的经销商进行处理，请勿擅自处置。请客户认真阅读本手册的注意事项。

配线配电

参考不同型号产品的耗散功率与供电/AC进行配线建议用户搭配不低于以下的配线径规格，以获得更佳的综合性能。

标配电压：230V~

型号	耗散功率	配线径规格
V4.25	3500W	$\geq 3.2\text{mm}^2$

标配电压：110V/120V~

型号	耗散功率	配线径规格
V4.25	3500W	$\geq 3.2\text{mm}^2$

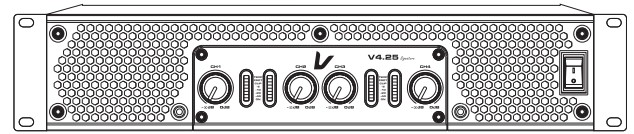

产品介绍

- V4.25产品是一款全新的高效率和大功率的开关电源功放。与之前产品相比较它在音质上有了突破性的改进，带给您的将是全新声音的享受。
- 采用第二代Class I电路拓扑，保持了纯模拟放大器的风格，同时具有类似于D类的高效率；
- 采用第三代稳压式开关电源，即使输入电压大幅波动时也能保持稳定、强劲功率输出。

功放模块及开关电源模块选材优势

- 采用AI插件工艺，从而具有以下两个优点：
 - 1) 每一颗元件都有足够的余量；
 - 2) 在恶劣的环境中更能抵挡日积月累的灰尘对电路的影响；
- 功率管直接安装于散热器上（无云母片等介质绝缘导热）减小了功率管的热阻，可有效降低功率管的瞬升高温；
- 选用高品质可调电位器，尽可能的减少了模块之间的连接导线及接口；
- 以上这些细微的设计都是为了确保新一代产品更加稳定、可靠。

前面板:

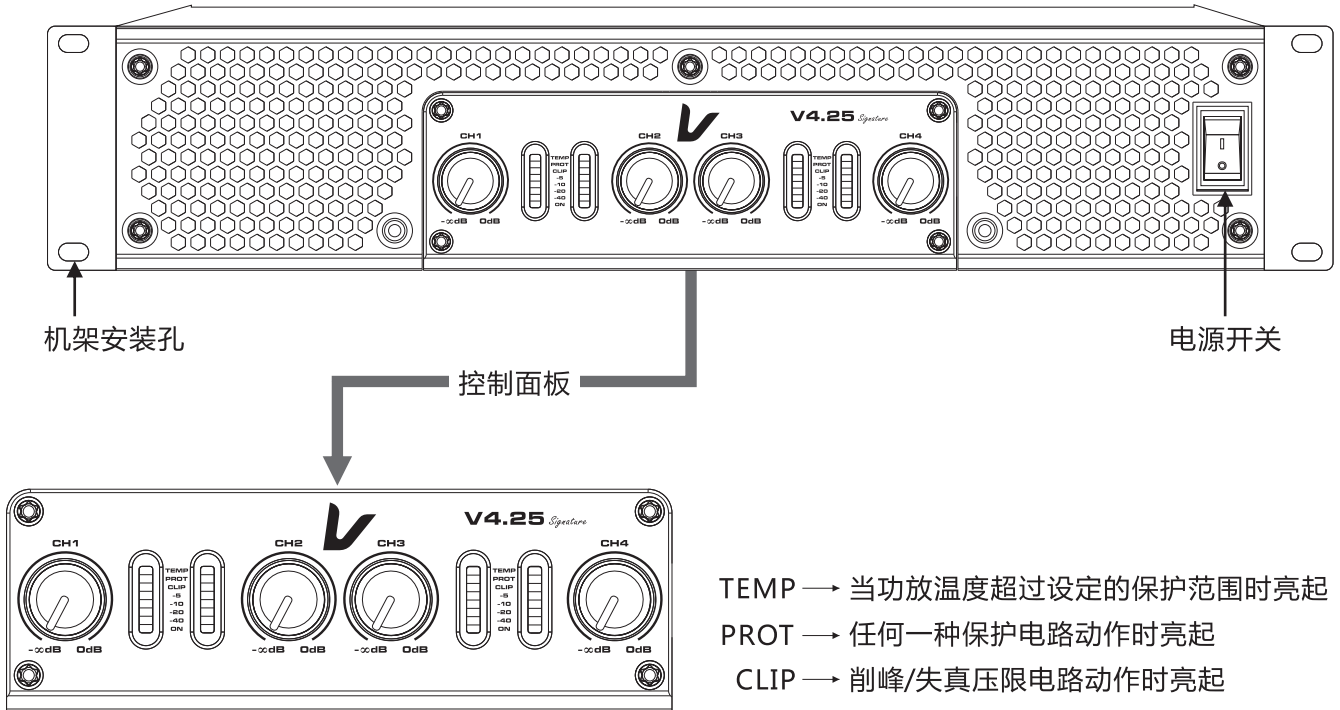

- TEMP → 当功放温度超过设定的保护范围时亮起
- PROT → 任何一种保护电路动作时亮起
- CLIP → 削峰/失真压限电路动作时亮起
- 5dB → 输出信号幅度距满功率约为-5dB
- 10dB → 输出信号幅度距满功率约为-10dB
- 20dB → 输出信号幅度距满功率约为-20dB
- 40dB → 输出信号幅度距满功率约为-40dB
- ON → 开机后亮起
- CH1-CH2-CH3-CH4 → 增益控制器旋钮

滤尘网清洁操作指引



在工程建设完成时，应对滤网进行首次清洁。
在往后的时间，应根据实际的情况，建议每季度定期进行清洁一次。

不允许拆除该滤网继续使用本产品，否则将影响本机的使用寿命。

在此情况下产生的故障，将被认定为脱保！

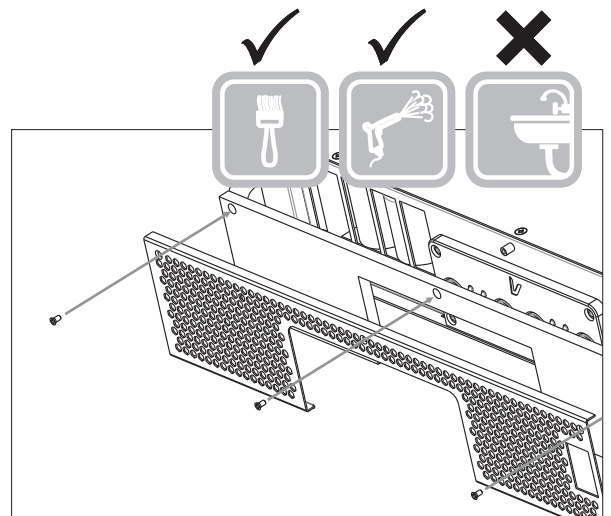

后面板

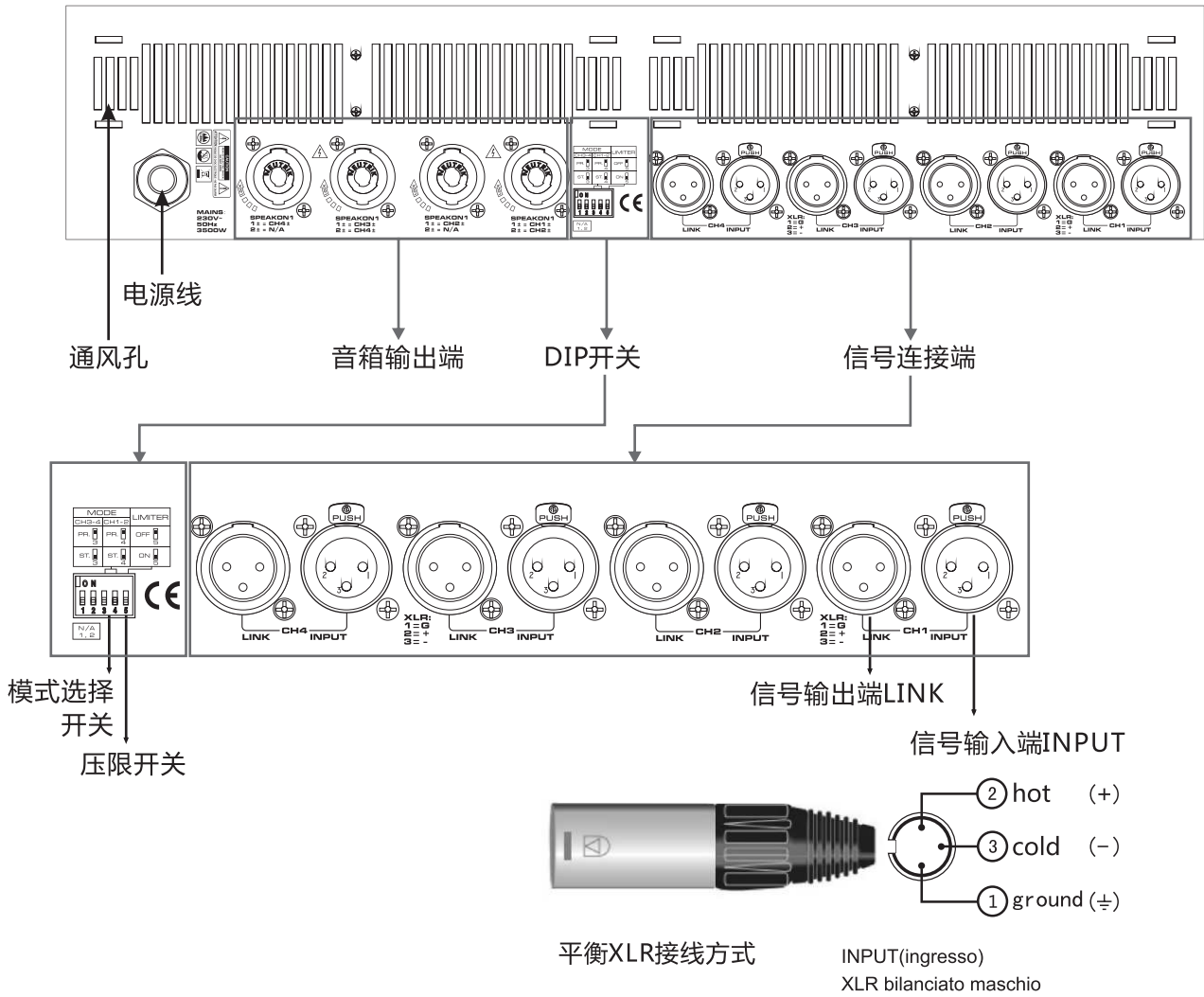

音箱输出端

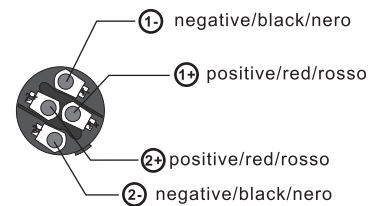
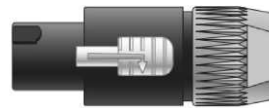
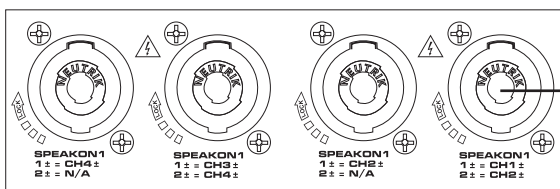

立体声或并接模式下
可工作在2~16欧



焊接质量很重要！
虚焊或是焊接错误，
将可能影响到正常
使用甚至产生故障。

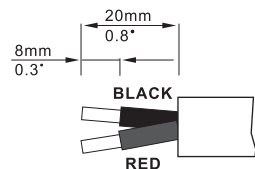

型号	V4.25
功率	
8Ω立体声功率	1300Wx4 *
4Ω立体声功率	2100Wx4 **
2Ω立体声功率	2500Wx4 **

其他参数

频率响应	20Hz-20kHz , +0/-1.5dB
总谐波失真	≤0.05%
阻尼系数	≥800
信噪比	≥80dB
输入灵敏度	32dB
输入阻抗(平衡/不平衡)	20kΩ/10kΩ
电压增益	32dB
输出类别	Class I™
冷却	从前到后抽风
保护功能	软启动、直流、VHF、短路、过载、削峰/失真压限、峰值电流限制、过热、开机音量渐大

连接器

输入部分	平衡输入XLR母插座/平衡并接XLR公插座
输出部分	NL4音箱螺旋座

使用功能

面板功能	电源开关/音量控制旋钮/电源指示/输入电平/削峰压限指示/保护指示/超温保护
后板功能	立体声/并接模式选择开关，压限选择开关

产品尺寸

产品外形尺寸(Wx Lx H) (mm)	483x412x89
外包装尺寸(Wx Lx H) (mm)	595x565x170
电源	16A电源线

注意：1. * 以上功率是使用40ms脉冲1kHz正弦波在1%总谐波失真下测量得出;
 2. ** 以上功率是使用20ms脉冲1kHz正弦波在1%总谐波失真下测量得出。

机箱尺寸 (mm)

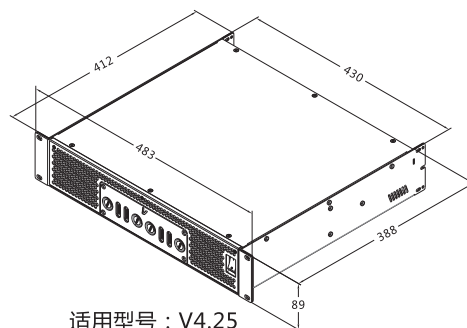

通电后，无任何反应

马上用万用表测量插座是否有电，在没有万用表时可用试电笔，但必须灯泡显示明亮，否则可怀疑电压不正常。若插座电压正常，供电无怀疑后，通电的功放仍然无任何反应，则可判断该功放有故障，需要专业人员进行进一步故障判断。

功放无声音输出

1、首先判断输入的信号是否正确

⚠卡侬XLR的2/3脚有无反接的可能，地屏蔽线是否连接可靠。根据输入线路的设计不同，可能在以上有些产品会表现正常，而有些则无声，请必须按照2+、3-的方式连接。不可以采用比对其他功放（包括同厂产品）的方式判断。

2、面板指示信号灯不亮

排除信号线问题后，若功放无输入信号反映，可判断功放本身可能存在故障，需专业人员进行进一步故障判断。

3、输入信号正常但仍无声

正面的信号指示灯是否有闪动和根据音量大小而跳跃，若正常，而无声音输出，立即检查连接的NL4插头是否连接正确（±1，±2的连接问题）是否连接牢固。若以上都无问题，仍然无声，可以尝试其它通道观察是否有相同的现象。若还是一样，请立即更换另一个NL4插头再作连接尝试。

⚠根据经验，可能有某些插头和该产品的插座接触不良导致的。

功放输出声音失真

1、失真表现为小声音已经很明显能听出声音有破裂声在排除信号本身和音箱的问题后，可判断为该功放可能存在故障。需专业人员进行进一步故障判断。

2、某个频段失真

首先判断音箱本身是否能承受该功放的输出功率，一般在95~105分贝时判断，再大的音量输出不作评论。本篇幅只讨论功放自身问题的排除。若是在中频段声音有轻微破裂尾音，并且在音量越小时表现为越明显，可判断为功放可能有交越失真，此失真声音比较容易和音箱本身高频激励器故障混淆，请做出判断前最好再连接其它判断为正常性能的音箱比较测试一下。

3、大声压时失真

在小声压时表现正常的情况下，首先判断音箱对所播放音乐信号的大动态时的承受能力。请在合适的音量下聆听判断，若功放削峰指示灯（CLIP）时常亮起，请再降低音量后判断。音箱和功放都有适用的范围，请在所能接受的范围内使用，在超大音量下失真则可能功放及音箱都已经进入饱和状况，请适当降低音量使用。

功放保护指示灯（PROT）点亮

此指示灯点亮表明功放进入保护状态。形势不妙！

1、可能是温度过高、有高于4K的连续正弦波输出超过1秒、输出短路或接近短路等。以上情况可恢复的。并非故障。等恢复后可继续使用。但过热会等待较长时间才可恢复。并且出现过热时必须检查产品的风扇是否运作正常，空间温度是否过高等，须排除问题后才可继续运作。若怀疑音箱短路，可以用万用表测量音箱线两端直流电阻是否低于2欧甚至1欧。（因电阻较小，为保证测试精度，请校准万用表后再测量）

2、此灯常亮，不可恢复

此类情况一般为功放本身故障导致，请联系维修人员跟进。

有交流声（哼声或称之为电流声）

1、功放不插入任何信号就有交流声

请将功放搬离于系统电源地线隔离的位置继续测试，只连接火零N/L，不连接地线。若输出还是有交流声，可判断为产品本身有问题，请与维修人员联系。

2、连接系统后有交流声

此现象为系统各单元设备的地电位不同而产生的。多数出现在供电为三相电时，各设备连接不同的相线，甚至不同上庄电源，零线带电导致，并非功放故障。

解决办法超出本说明书叙述范围，这里附赠解决经验，仅供参考，本厂不对此叙述负责！

A、梳理用电，尽可能使用同一配电箱的电源。

B、在必须接地的情况下，将不同的接地点强迫接为一点，在此动作前，请判断地线电位必须为零，若地线本身带电，则表明地线可能与零线相连。请先解决此问题。

C、我们不建议浮地使用设备。









以下情况表示放大器需要维修

- 1.产品冒烟或者发出严重烧焦味而不能使用时
- 2.机箱严重凹陷或者变形
- 3.产品浸入液体中
- 4.内部部件松动
- 5.加电时交流断路器自动跳开或保险管熔断

Important Safety Notice

1. Read the rules, pay attention to all warnings, and comply with these rules.
2. It is forbidden to spray liquid around the product. Please do not place the liquid container above the product, such as vases, etc. The dry cloth and air pressure gun can be used for cleaning.
3. Be careful not to form a hot air circulation. Please install as the recommended way.
4. Do not install the product near the heat source, and try to keep the environment temperature below 35°C.
5. ⊕ Ground protection, when connect to power supply, corresponding ground protection measurements should be taken.
6. Please protect the power cord from treading and squeezing, especially the plug, power socket and connected devices.
Warning: Power plug/Equipment coupler, as a circuit cutting off device, should be kept available at any time.
7. Must be in accordance with the following sequence switch to use the product: Turn on: Pre-Amp ~ Amplifier;
Turn off: Amplifier ~ Pre-Amp.
8. Before power on, must ensure that the power supply voltage in accordance with the requirement of the product.
9. If input signal parallel with more than three power amplifiers, it is suggested to use signal distributor to make sure no distortion of the input signal.
10. Do not connect an output port of one channel into an input port of the other channel in the same amplifier. Do not connect an output port into an output port of another amplifier in series or parallel.
11. When configure an amplifier into a system, the output power of amplifier should be 50%-100% higher than the nominal power which is the same impedance with the loudspeaker. And be careful to use the bridge mode.
12. It is forbidden to connect an oscilloscope probe into an amplifier output interface in state of bridge when the amplifier is being maintained, to avoid amplifier or oscilloscope got broken.
13. Suggest: 1) Please use qualified NL4 SPEAKON connectors.
2) Please make the appropriate power distribution when more than one amplifier working at the same time, to achieve qualified using environment.

Safety instructions

 <p>When stacking non-horizontally, the air outlet should be upward or be straight to the vent.</p>	 <p>This product is suitable for safe use below altitudes 2000m.(Only for our company Switching Mode Power Supply equipments)</p>
 <p>Input/output connection cables can not be stacked on the air outlet of the product. They should be tied up on both sides of the amplifier.</p>	 <p>This product is suitable for safe use of non tropical climate conditions.</p>
 <p>The ambient temperature should be lower than 35°C while running the amplifier</p>	 <p>The materials which need to be technically recycled and can not be placed in the trash can.</p>
 <p>Please verify the temperature in the cabinet when the project is debugged, and should be kept below 35°C even though in the extreme conditions.</p>	 <p>The lightning bolt triangle is used to alert the user To the risk of electric shock. Non-professional Qualified technicians do not open top or bottom covers for maintenance</p>



WARNING: To reduce the risk of fire or electric Shock, do not expose this apparatus To rain or moisture.

Welcome

Thank you for purchase our exciting products. The V4.25 power amplifier is special design for sound system in large stadium tour theater. In order to make a better performance, please read this manual very carefully before you use the V4.25 amplifier.

Unpacking

Please make sure if the appearance of the power amplifier was damaged or not during the transportation after you opened the package. Please make sure the preset voltage is matched with your local AC voltage (please check it on the rear panel of the power amplifier). We suggest you retain the package in case you need them for further transportation.

Important safety issues

Our products has already taken the safe requirement in to consideration and all the finished products have been tested under the requirement of the government before sale. Users should read the notice in this manual before operation as there is dangerous high voltage and electricity inter the products. It will increase the chance of getting shock by the electricity if the product falls down, recess in the appearance, soaked or there were some parts loose internal. If there are problems above, please turn off power immediately and send the defective units to local distributor for service.

Power & Wiring distribution

Referring to the power dissipation and power supply/AC of different product for wiring We suggest the users to match not less than the following wiring size specifications, to obtain the better comprehensive properties.

The Standard Voltage : 230V ~

Model	Power	Cable size
V4.25	3500W	$\geq 3.2\text{mm}^2$

The Standard Voltage : 110/120V~

Model	Power	Cable size
V4.25	3500W	$\geq 3.2\text{mm}^2$

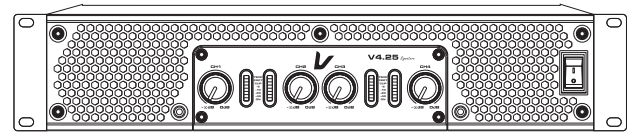

Product Introduction

- V4.25 power amplifier is a brand new SMPS with very high efficiency and ultra high output power. Compare with the old products it has a great improve in the sound quality.
- We used the second generation "Class I "output circuitry which is our patent technology can have the high efficiency of "Class D" and the sound quality of "Class A".
- Adopt the third generation voltage-stabilizing SMPS can keep stable and strong output power even the input voltage fluctuate a lot.

Power amplifier module and switch power supply module

- All adopt the AI plug-in technology, thus has two following advantages:
 - 1) Every element has enough margin.
 - 2) It can protect the circuitry from the accumulated dust In the bad environment.
- Power transistor installed directly on the radiator (no mica plate and dielectric insulation thermal conductivity) thus can reduce the thermal resistance of power transistor and can effectively reduce the instantaneous high temperature rise of power transistor.
- Selects high quality adjustable potentiometer, as far as possible to reduce the wire connection and interface of the modules;
- **These designs are aim to ensure the new generation products more stable and reliable.**

Front panel

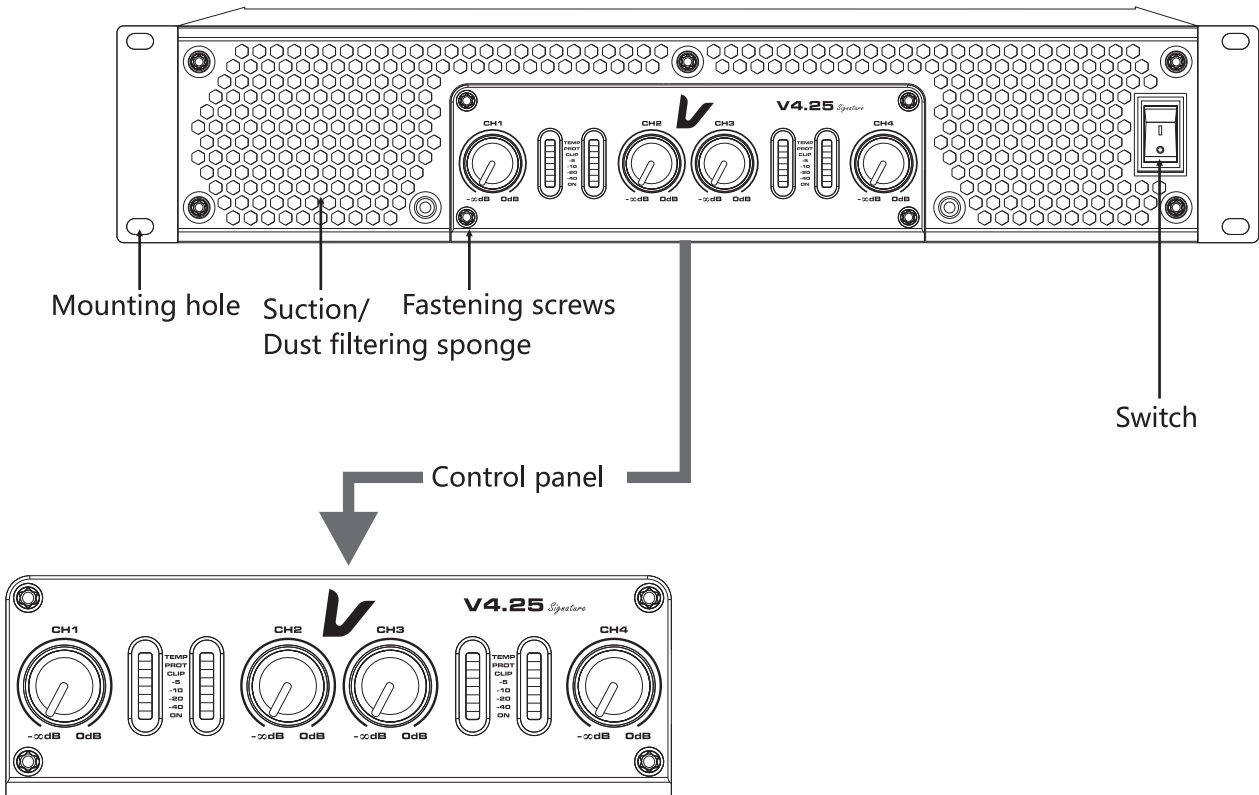

- TEMP → Light when amplifier temperature higher than setted protection range
- PROT → Lights up in every protection circuit.
- CLIP → Lights up in clip/distortion limited circuit.
- 5dB → Light when output signal around -5dB than full power
- 10dB → Light when output signal around -10dB than full power
- 20dB → Light when output signal around -20dB than full power
- 40dB → Light when output signal around -40dB than full power
- ON → Lights up when turned on
- CH1-CH2-CH3-CH4 → Gain Controller Knob

Cleaning guide of the strainer mesh



The first time cleaning of the strainer mesh should be right after installation. Recommend to clean the strainer mesh quarterly

Please do not run the product with the strainer mesh, or it makes the service life of the product shorten.

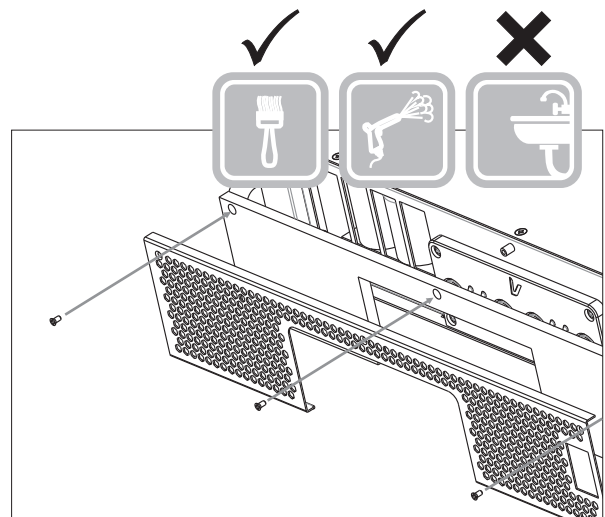

Rear Panel

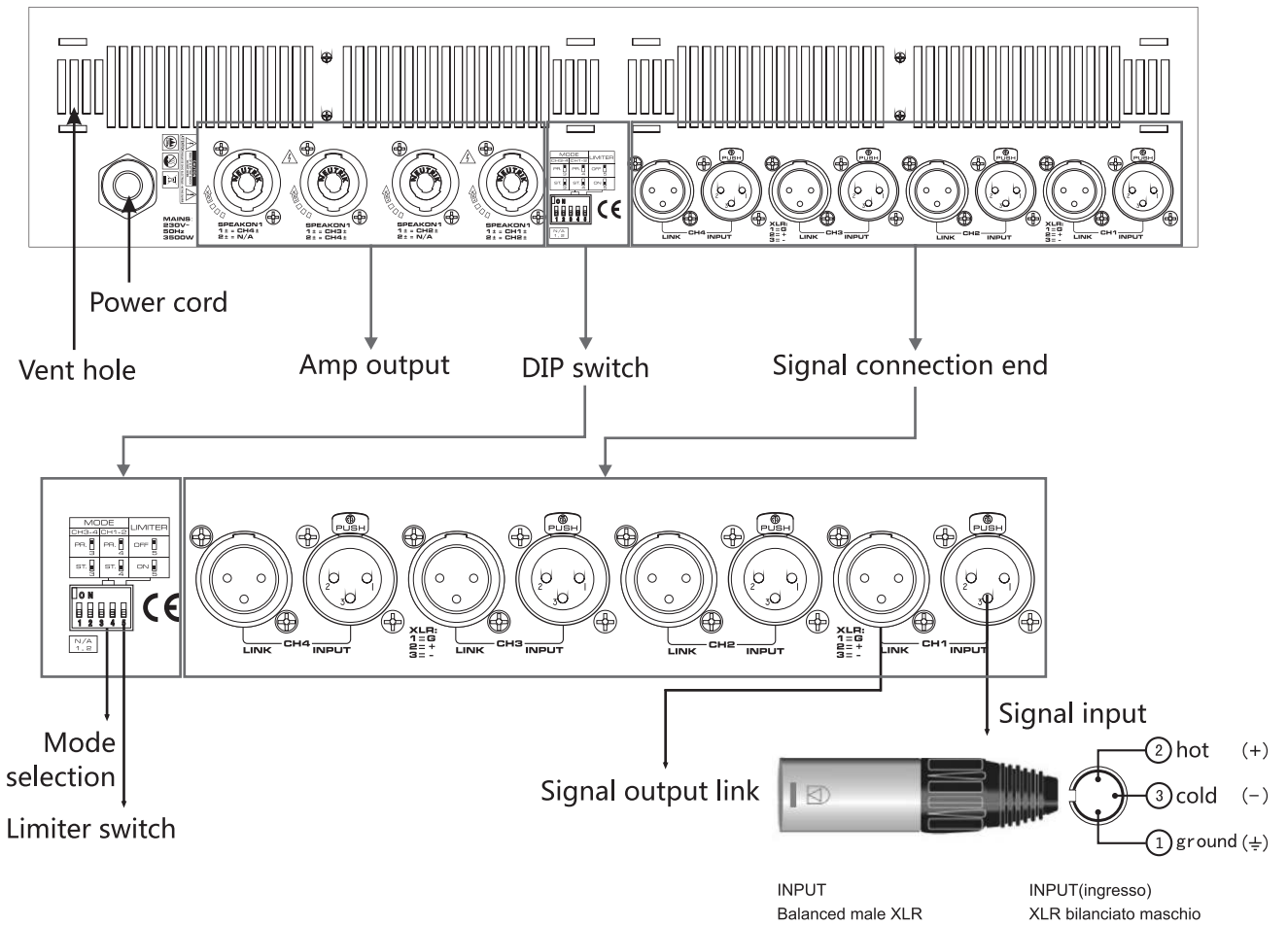

Speakon output

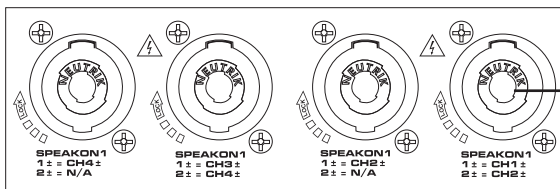

It can work from 2-16ohm in stereo or parallel mode

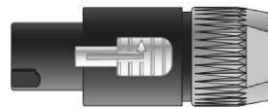

The quality of your soldering is very important
Virtual welding or soldering errors, Would be likely to affect the normal Use or even failure

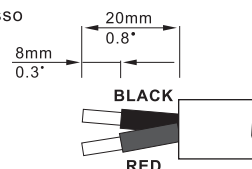
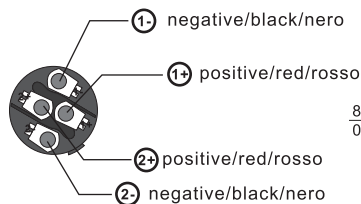

Model	V4.25
Output power	
8Ω stereo	1300Wx4 *
4Ω stereo	2100Wx4 **
2Ω stereo	2500Wx4 **

Other Specifications

Frequency response	20Hz-20kHz(+0/-1.5dB)
THD+N	≤0.05%
S/N rate	≥80dB
Damping factor	≥800
Input sensitivity	32dB
Input impedance(bal/unbal)	20kΩ/10kΩ
Voltage gain (8 ohm)	32dB
Output circuitry	Class I™
Cooling	Air flow from front to rear
Protection	Soft start, VHF, DC, short circuit, over load, clip limit, peak current limit over heat, progressive volume

Connection

Input	Balance input XLR-F, Balance output XLR-M
Output	NL4 SPEAKON
Function	
Front panel	Power switch, Volume control
Rear panel	Stereo/Parallel mode selector switch, Limiter selector switch

Dimensions

Product Dimension(mm)	483x412x89
Packaging Dimension(mm)	595x565x170
Power Supply	16A power cord

Remarks : 1.*,The power is tested under the condition of 40ms burst,1kHz sine wave and 1% THD
 2.**,The power is tested under the condition of 20ms burst,1kHz sine wave and 1% THD

Dimensions(mm)

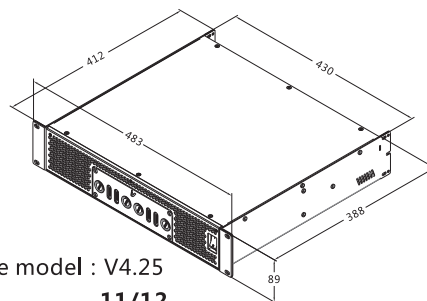

Suitable model : V4.25
 11/12

After powered without any response

Measure the outlet with a multimeter to check if there is power available and when no multimeter, you can have a test pencil. If the power supply is normal and the amplifier still no response when powered then there is something wrong with the amplifier, need professional person to check it.

No signal output

1. First check if the signal input is right.

⚠️ Check the connect of XLR, if the 2 and 3 reverted or the ground is reliable. Different circuitry design will have different connect way of the XLR, please follow the 2+, 3- to soldering.

It can not be judged by comparing with other amplifiers (including other amplifiers in the same factory).

2. The signal light don't lights up

If all the signal input is fine and the signal light don't lights up then may the amplifier has failure, you need to ask the professional person to check it.

3. Signal input normal but no sound

The signal light will flash with the change of input Volume, but now sound out, then you can check the connect of speaker if it is connect good and the wires are connect right (some times the problem of the wires connect, check its ± 1 and ± 2 connect), after the check above if still no sound out, please change a speaker cable and check again. Because some times also caused by the bad quality of the Speaker connector problem of the amplifier.

⚠️ Through experiences, it may caused by the bad connection of some plugs and the socket.

Output sound distortion

1. After check the signal and loudspeaker they are fine and still can hear distortion when small sound, then may the amplifier has failure, need professional person to check it.

2. Some frequency band has distortion

First, check if the loudspeaker already overload, normally judge it in 95~105dB for higher SPL we don't comment here. Here we just think about the failure recovery of the amplifier. If in the middle have some rupture sound and more smaller volume more obvious, then it should be crossover distortion of the amplifier and this kind of distortion is easy to confuse with the failure of loudspeaker itself. If the amplifier have problem then you should send back to the manufacture for repair.

3. Distortion is High SPL

If the sound is normal when small volume and then you need to check the limit SPL of the loudspeaker. You can listen it in suitable volume and if clip light works, then you need reduce the output. Both loudspeaker and amplifier have limit, you should use them in their limit if in very high SPL they have distortion you should take care of them and reduce the output to the right position.

The protection light blinks

When the PROT light works, the amplifier into the protection mode.

1. Maybe the temperature is too high or output short or near short and they are not failure they can recovery after you can use it normally. But over heat will take more time to recovery. Also when over heat happened you should check the fan and the temperature of the install environment, if does you should solve the problem then can use amplifier. If you think the speaker was short, you can with a multimeter to check if the resist is lower than 2 ohm or 1 ohm with DC (Please calibrate the multimeter to measure for accuracy because of the small resistance).

2. If the PROT light always light up then it should be the problem of amplifier, you should send it back to professional person for repair.

Hum in the system

1. Hum exists even when there is no signal

Please keep the amplifier away from earth wire of power supply cables, just connect the fire wire and zero wire, no ground wire. If the hum is still existing, it can be judged that there are some problems in the amplifier. Please get in touch with professionals.

2. Hum exists when the system is completely connected

This is caused by the different ground voltages in difference devices in the system, mainly happens when the power supply is under three-phase distribution condition, each device is connected to different phase. This is not caused by amplifier.

Solution experiences, just for reference

- A. Combing the electricity, the power distribution box using the same one for all if possible.
- B. Make sure the grounding wire potential is zero and force the different grounding wire to the same level, if the grounding wire itself charged, indicates that the wire may be connected with the zero line. Please solve this problem.
- C. If unavailable above, then only to disconnect the ground wires of all devices, which helps to reduce the AC. But this is not meet the safe use of electricity, users must know what will happen if to do in this way. We do not recommend the floating use.

The amplifier is required maintenance in the condition below:

1. If the amplifier smokes or smells burning.
2. If the cabinet has severe indentation and deformation
3. If the amplifier are dipped into the water
4. If the internal components loosen
5. If AC breaker skips out when current increases.

Verity audio reserves the right to make any changes to the product specifications without prior notice.
Final specifications to be found in the user manual.

